

2026

SLX 260 SURF



Sea Ray®

LUXURY MEETS THRILLING PERFORMANCE

Blending next-level luxury with innovative NextWave™ surf technology, the SLX® 260 Surf is crafted to offer elevated experiences for casual cruisers and thrill seekers alike. A Mercury Marine® propulsion system and intuitive user interface provide exceptional performance for watersports, while improved seating and easy-to-use amenities ensure comfort and fun on the water for everyone. Whether you enjoy carving waves or sharing carefree evenings with friends, the SLX 260 Surf shines in delivering the best of both worlds.





2026 SLX 260 SURF

Sea Ray

STANDARD SPECIFICATIONS



STANDARD PROPULSION

Mercury® MerCruiser® 6.2L MPI ECT
Bravo Four S® with DTS (350 hp / 261 kW)



CRUISING SPEED

28–32 mph / 45–51 kph



WIDE OPEN THROTTLE (WOT)

44–46 mph / 71–74 kph



FUEL CAPACITY

75 gal / 284 L



RANGE

127 mi / 204 km (cruising speed)
88 mi / 142 km (WOT)



LENGTH OVERALL

25'9" / 7.85 m without anchor
27'3" / 8.31 m with anchor



BEAM

8'6" / 2.59 m



BRIDGE CLEARANCE

8'3" / 2.51 m (tower up)
6'4" / 1.93 m (tower down)



DRAFT

48" / 122 cm (sterndrive down)
34" / 86 cm (sterndrive up)



DRY WEIGHT

6,198 lb / 2,811 kg



WATER READY WEIGHT

7,660 lb / 3,475 kg (fully optioned)



DEADRISE

21°



WATER CAPACITY

14 gal / 53 L (requires
Water System Bundle)



HOLDING TANK

6 gal / 23 L (requires
Water System Bundle)



BALLAST CAPACITY

1,800 lb / 816 kg



CAPACITY

12 people / 1,750 lb / 794 kg



1) Speed determined by GPS. Fuel consumption based on total usage by engines. MPG computed from MPH and GPH. Range based on 90% of total fuel capacity.

2) The performance data shown is valid only for the specific boat tested and the conditions that existed when the test was performed. Many factors may affect performance, including but not limited to, installation of certain options; vessel loading and trim; weather and sea conditions; and engine, propeller, and hull bottom conditions. Sea Ray makes no guarantee whatsoever that this performance will be repeated on this boat at a later date and/or at any time on a similarly equipped boat.

AT A GLANCE

A NEXTWAVE™ SURF SYSTEM
For an exceptional wakesurfing experience, the boat features NextWave™ innovations, including a tapered transom design, a hard-tank ballast system, electric surf tabs and an intuitive user interface.

B WATERSPORTS TOWER
The electric watersports tower with an integrated Bimini top and surf tow points allows you to pull wakesurfers with ease.

C DELUXE COCKPIT
The cockpit showcases an updated layout with deeper ergonomic seating for a smoother ride.

D REIMAGINED WINDSHIELD
For a more enjoyable cruising experience, the windshield has been redesigned to be angled level with the horizon when the boat is planing.

E PORT-SIDE COMPARTMENT
The convenient port-side compartment can be used to store gear or upgraded to a head for uninterrupted boating.

F PLUSH BOW SEATING
The bow offers lounge-style seating with foldable armrests. Choose the Comfort Bundle to add a teak table and filler cushion.

G BOW UPGRADES
With the Anchor Bundle, the bow can be enhanced with a stainless steel anchor, windlass, rope and chain.



AT A GLANCE

A SEAMLESS CONTROL
The helm is equipped with a dual Digital Dash for effortless captaining, including 9" Simrad® NSX® touchscreen displays with Mercury® SmartCraft® Connect.

B FUSION® AUDIO
Listen to music out on the water with premium sound from the Fusion® stereo or select the Entertainment Bundle for a Fusion® Premier audio system.

C VERSATILE SUNPAD
The expanded sunpad presents an inviting place to relax. A compartment under the sunpad can be filled with drinks to become an integrated cooler or kept empty for extra storage.

D OPTIMIZED STORAGE
Integrated storage optimized for space has been incorporated throughout the boat. A storage area under the sunpad is ideal for stowing floating water mats and inflatables.

E SURF POWER
To create the ideal wake for wakesurfing, the boat is powered by a standard Mercury® MerCruiser® 6.2L MPI ECT sterndrive engine with a forward-facing Bravo Four S® drive and SmartCraft® Digital Throttle & Shift (DTS).

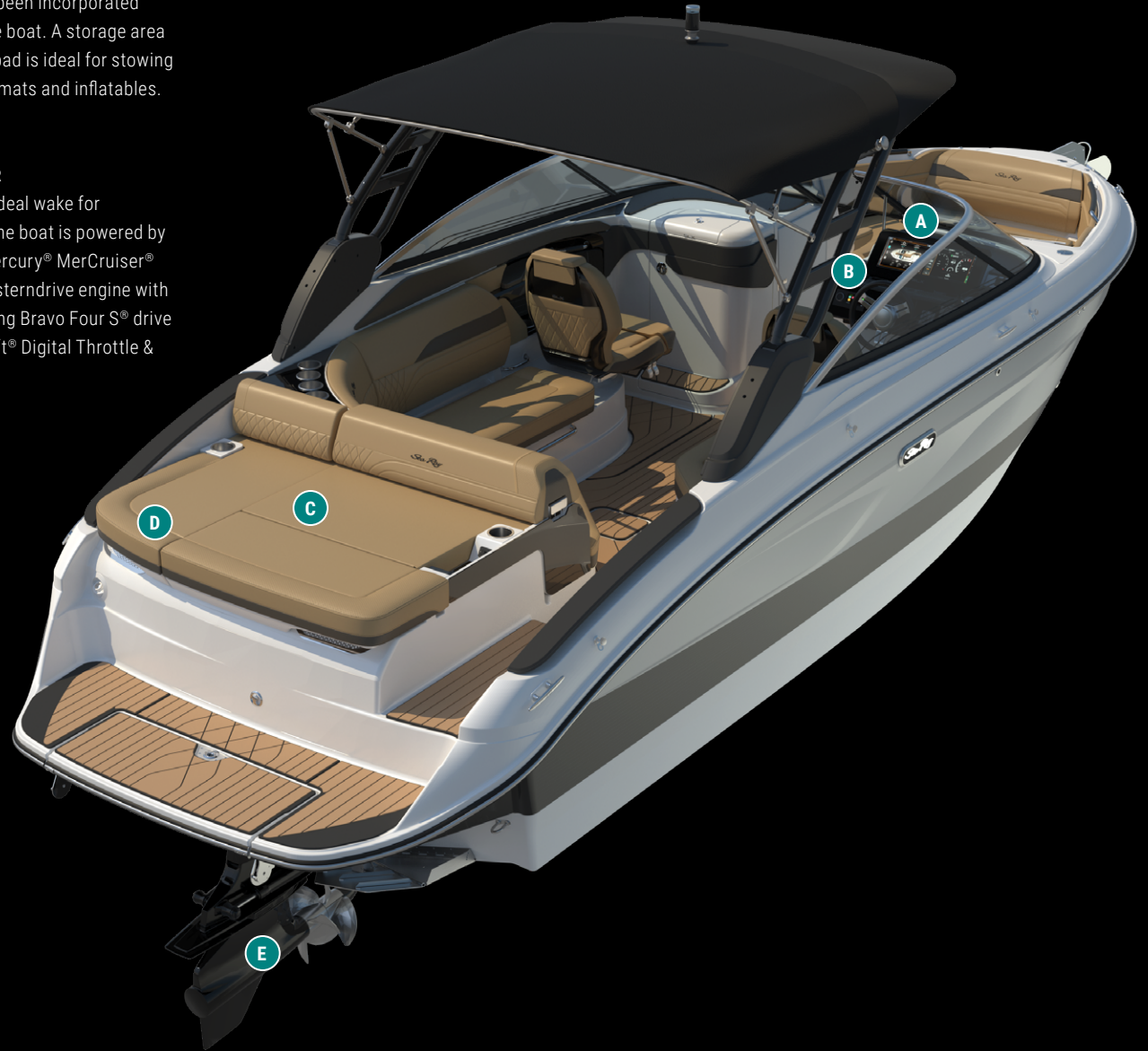



2026 SLX 260 SURF

Sea Ray®



2026 SLX 260 SURF

Sea Ray®

COLORS & MATERIALS

EXTERIOR COLOR SCHEMES



Arctic White (standard)



Onyx Black



Horizon



Sea Ray Blue



Quantum Blue



Kingfisher Teal

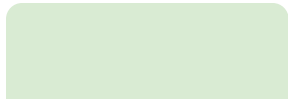

Neo Mint Green



Rally Red



FULL HULL



HULL SIDE

Hull bottom available in Arctic White or Onyx Black only



ACCENT STRIPE

Available with full hull color scheme only



THREE ZONE HULL

VINYL UPHOLSTERY COLORS



Ivory (standard)
White base with brown accents



Dune
Tan base with brown accents



Stone
Light gray base with gray accents

CANVAS



Sunbrella® Black

BOW & COCKPIT FLOORING

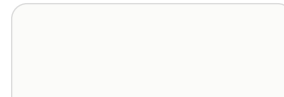

Non-skid fiberglass (standard)



SeaDek® – Brown



SeaDek® – Gray



Infinity woven vinyl – Brown



Infinity woven vinyl – Gray

SWIM PLATFORM FLOORING

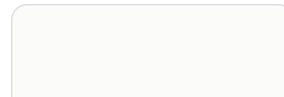

Non-skid fiberglass (standard)



SeaDek® – Brown



SeaDek® – Gray

STANDARD FEATURES

BOW & COCKPIT

- Cup holders, stainless steel (17)
- Floor liner, fiberglass
- Lighting, LED (courtesy)
- Outlets, 12V accessory (helm & transom) – 2
- Outlets, USB-A & USB-C dual port (5)

DOORS

- Bow walkthrough with hinged windshield door & fiberglass block-off door
- Hatch for bilge access, gas-assisted
- Transom door, fiberglass

SEATING

- Bow seating, U-shaped with foldable armrests & hinged cushions
- Cockpit social area
 - Aft L-shaped bench seating
 - Opposing starboard bench seating
- Helm bucket seat with swivel, slider & flip-up bolster
- Port companion bucket seat with swivel, slider & flip-up bolster
- Sunpad

STORAGE

- Bow storage (under seating)
- Cockpit storage (under seating)
- Cooler storage (cockpit)
- Side panel tubs (cockpit)

HULL & DECK

- Cleats, stainless steel through-bolted (8") – 6
- Deck fill plate, stainless steel
- Drain plug
- Eyes, stainless steel (bow & stern)
- Handrails, stainless steel (cockpit)
- Handrails, Chil Cool Technology vinyl-wrapped stainless steel (bow & cockpit)
- Horn, built-in
- Light, removable (stern)
- Lights, navigation (stainless steel) – integrated into deck
- Rub rail, PVC with stainless steel insert
- Ski tow eye, stainless steel (transom)
- Stringer system, fiberglass
- Swim platform with manual submersible step
- Thru-hull fittings, stainless steel
- Windshield, tempered tinted curved glass with stainless steel header

STORAGE

- Anchor storage
- Glove box, lockable (port console door)
- Integrated cooler or storage, fiberglass with drain (under sunpad)
- Storage (transom walkway floor)
- Storage with lockable door (under port console)
- Transom storage for gear & inflatables with gas-assisted fiberglass lid (under sunpad)

TOPS & CANVAS

- Watersports tower, electric with integrated Bimini top & side-mounted surf tow points

TECHNICAL

ELECTRICAL

- Battery charger, 12V onboard (triple bank)
- Battery switches
- Electrical system, 120V 60Hz
- Fuse block

FUSION® AUDIO SYSTEM

- AM/FM stereo (helm)
 - Bluetooth™
 - Digital Signal Processing (DSP)
 - Wi-Fi audio streaming with Apple AirPlay® 2
 - XS Series speakers (6.5") – 2 pairs

HELM

- Digital Dash, dual (9")
 - Active Trim control & monitoring
 - Chartplotter with preloaded charts (North America only)
 - CZone® digital switching
 - Mercury Marine® SmartCraft® Connect
 - Simrad® NSX® 9" touchscreen displays (2)
 - Transducer with depth, water temperature & fishfinder
- Mercury Marine® SmartCraft® Digital Throttle & Shift (DTS)
 - Active Trim speed-based automatic engine trim system with integrated GPS
 - Engine start / stop
- Parallel start system with battery parallel
- Sea Ray customized surf interface powered by Mercury Marine® Smart Tow®
- Steering, power-assisted with tilt wheel
- Switch panel with illuminated weatherproof chrome switches
- Tilt & trim, power

MECHANICAL

BALLAST SYSTEM

- Ballast system, hard tank subfloor (center bow, port midship and starboard midship) – controlled by Sea Ray customized surf interface

BILGE

- Bilge lighting, 12V
- Bilge pump, 1200 GPH 12V automatic (aft)
- Blower, 12V
- Oil filter, remote
- Vents, integral with water management system

FUEL SYSTEM

- Evaporative emissions fuel system
- Fuel lines, USCG compliant
- Fuel tank with anti-siphon valve & electric sending unit

UNDERWATER GEAR

- Propellers, stainless steel
- Surf tabs, electric

OPTIONS & ACCESSORIES

BOW & COCKPIT

- Boarding ladder, stainless steel concealable four-step with hatch (bow)
- Flooring, Infinity Luxury Woven Vinyl™ (snap-in)
- Flooring, SeaDek® (glue-down)

HULL & DECK

- Windshield wiper (starboard)

TOPS & CANVAS

- Mooring cover – black
- Power Tower with automated extended sunshade
 - Bridge clearance (tower up): 9'5" / 2.87 m
 - Bridge clearance (tower down): 6'8" / 2.03 m
- Skylon SkyLock Pro4 locking board racks – black
- Sunshade, manual with poles (bow seating)

TECHNICAL

ELECTRONICS

- 1st Mate™ Marine Safety & Security System (North America only)

MECHANICAL

BILGE

- Fire suppression system, automatic with manual override

HEATING

- Heater with Surfinit blanket, 3 outlets & 2 expandable hoses (cockpit)

UNDERWATER GEAR

- Propellers, high-altitude

WASTE SYSTEM

Options require Water System Bundle.

- Gray water system
- Pump-out head with sink & holding tank
- VacuFlush® head with sink & holding tank

TRAILERS

- Trailer, galvanized
- Trailer, painted

BUNDLES

ANCHOR BUNDLE

- Anchor, stainless steel
- Windlass with rope & chain

COMFORT BUNDLE

- Filler cushion (bow)
- Table with dedicated storage, teak (bow)
- Table with dedicated storage, teak (cockpit)

ENTERTAINMENT BUNDLE

ELECTRONICS

- Inductive charging station

FUSION® PREMIER AUDIO SYSTEM UPGRADE

- Apollo™ RA770 AM/FM stereo (helm)
 - Apollo™ Series amplifier, 8-channel (2400W)
 - Bluetooth™
 - Digital Signal Processing (DSP)
 - NRX300 remote unit (transom)
 - Apollo™ Series speakers (7") – 3 pairs
 - Apollo™ Series subwoofer (10")
 - Tweeters – 1 pair
 - Wi-Fi audio streaming with Apple AirPlay® 2

ESSENTIALS BUNDLE

- Cockpit & tonneau covers
- Fender clips, quick connect (6)
- Flagpole with base & U.S. flag
- Swim platform & port console storage flooring, SeaDek® (glue-down)

LIGHTING BUNDLE

- LED color-changing & white accent lighting package
 - Lighting for bow & cockpit
 - Lighting for cup holders
 - Underwater thru-hull (2 lights)
- Lights, docking
- Sea Ray badge, illuminated (hull)
- Sea Ray logo light projected onto cockpit floor

WATER SYSTEM BUNDLE

- Bow washdown
- Pullout sprayer (transom)
- Water pressure system with 12V pump & filtration

ANCHOR BUNDLE

Ensure your Sea Ray is secured wherever adventure takes you with factory-assembled features that make anchoring easy.



Stainless steel anchor

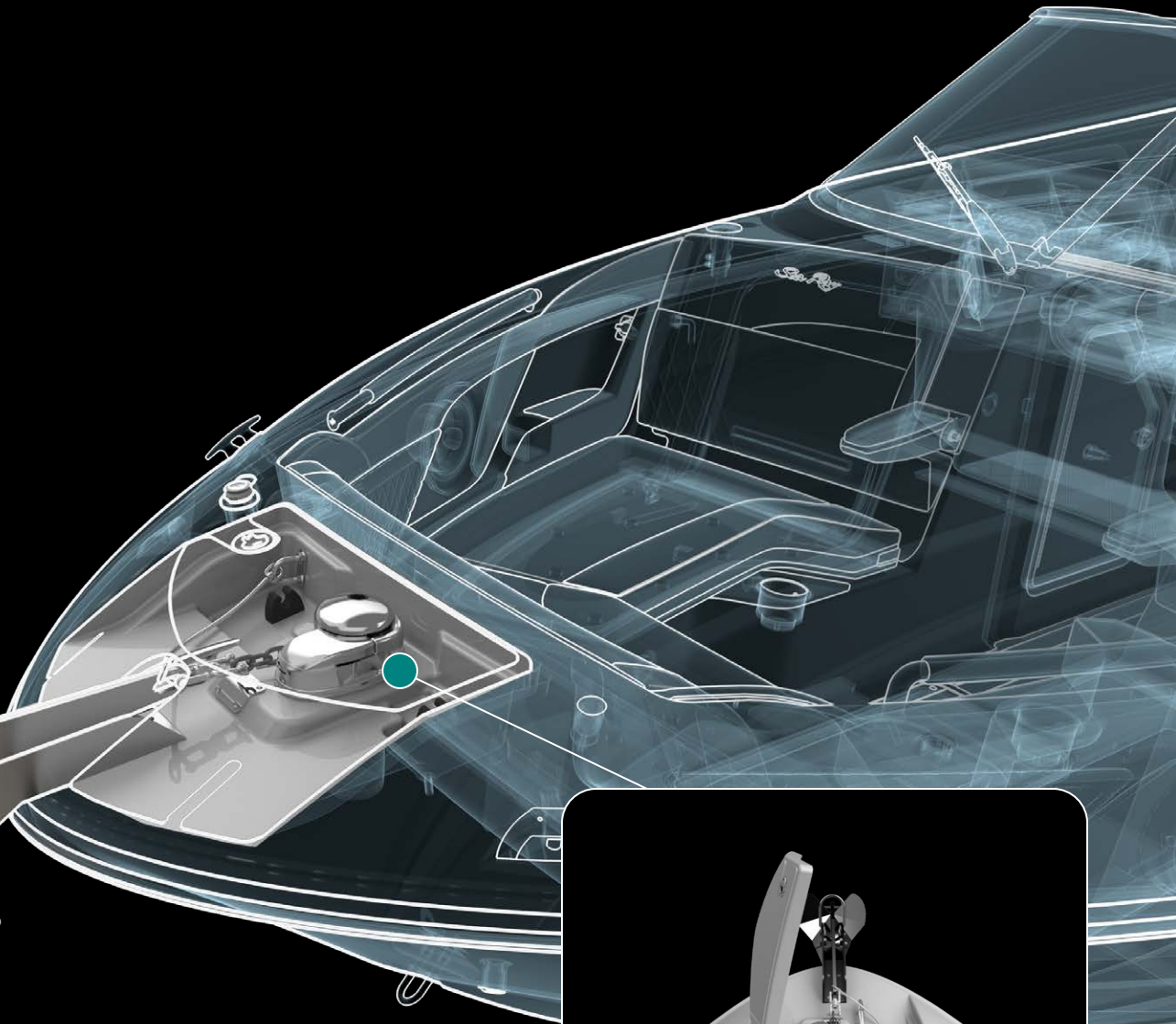
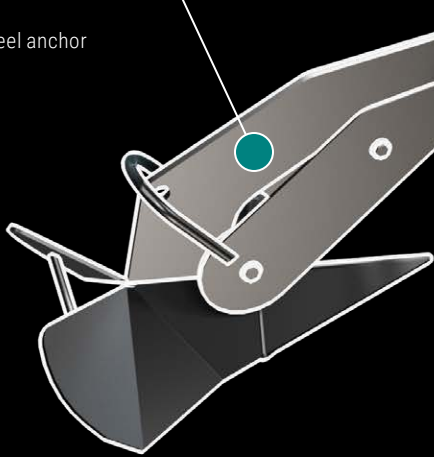

Windlass with rope and chain

COMFORT BUNDLE

Add a touch of luxury to your Sea Ray with stowable teak tables and a filler cushion that converts the bow into an expansive sunpad.

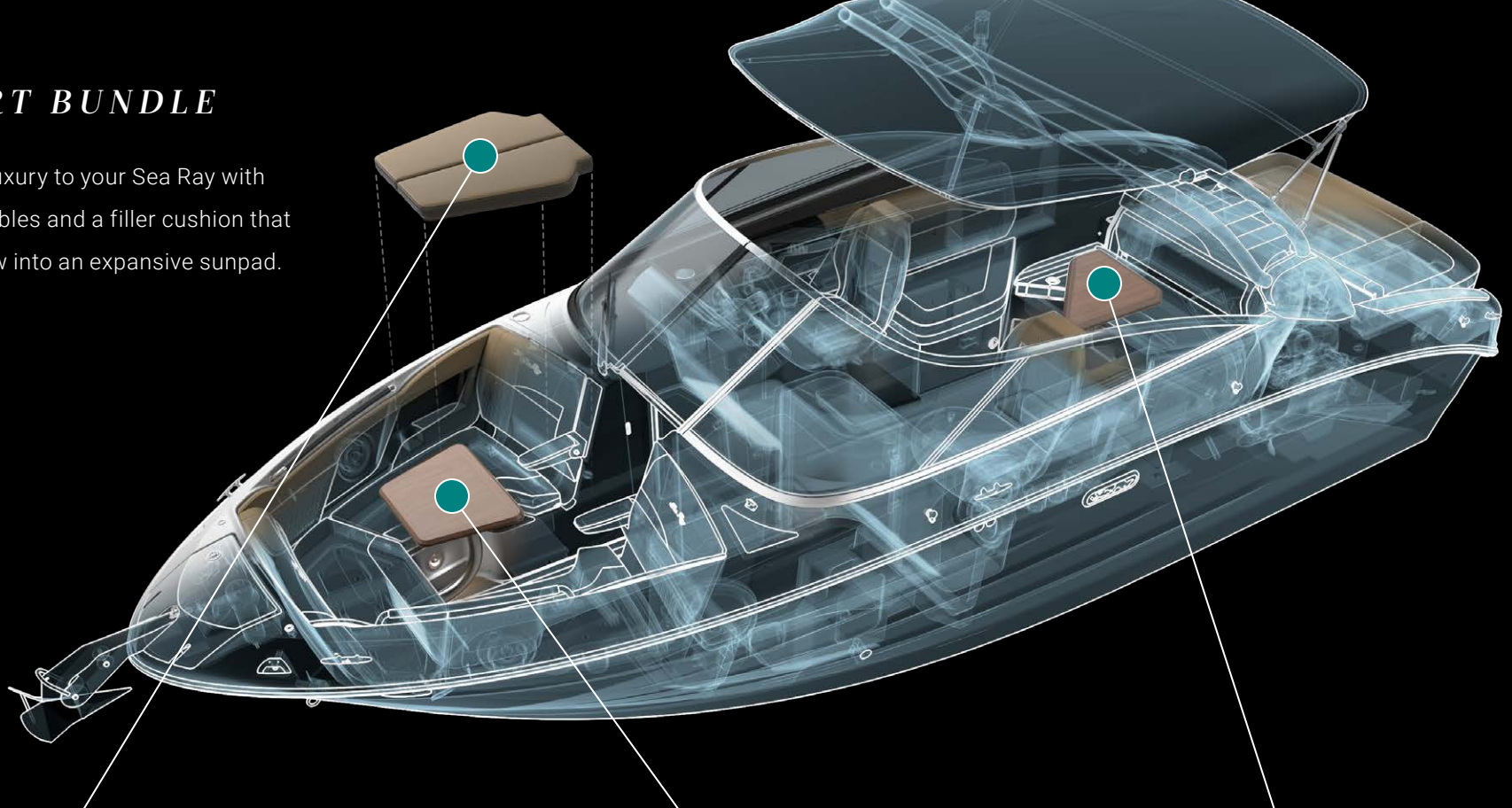

Bow filler cushion



Teak bow table



Teak cockpit table

ENTERTAINMENT BUNDLE

Keep the fun going all day long with an inductive charging station and the next level in marine audio entertainment from Fusion®.

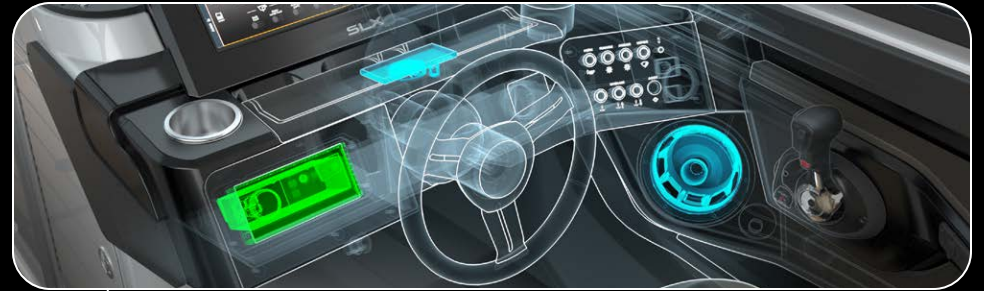

Fusion® Premier Audio system with Apollo™ RA770 stereo and inductive charging station

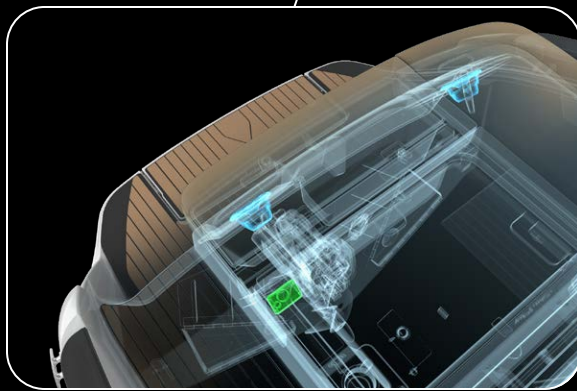
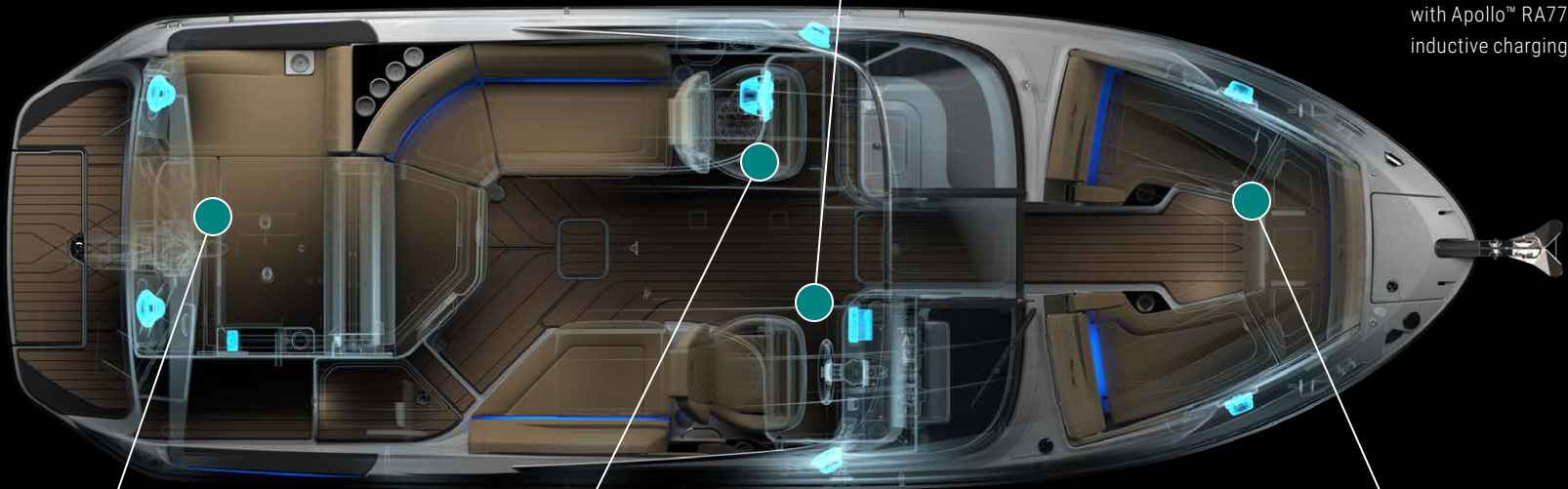

NRX300 remote unit and Apollo™ Series speakers

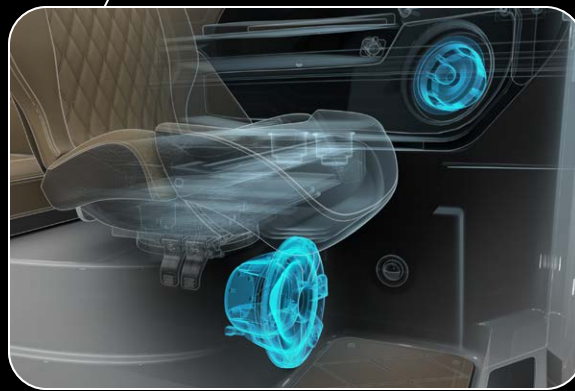

Apollo™ Series subwoofer and speaker

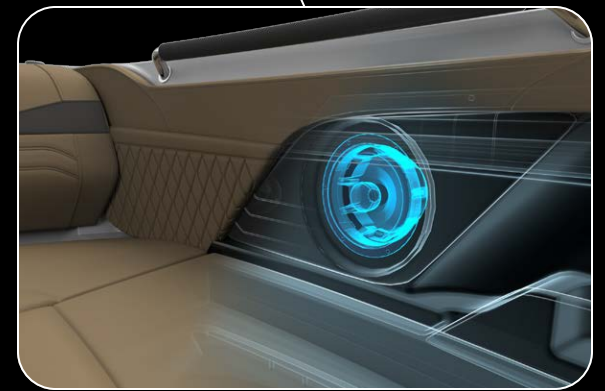

Apollo™ Series bow speaker

ESSENTIALS BUNDLE

For a superior boating experience, elevate your Sea Ray with some of the most popular accessories requested by boaters.

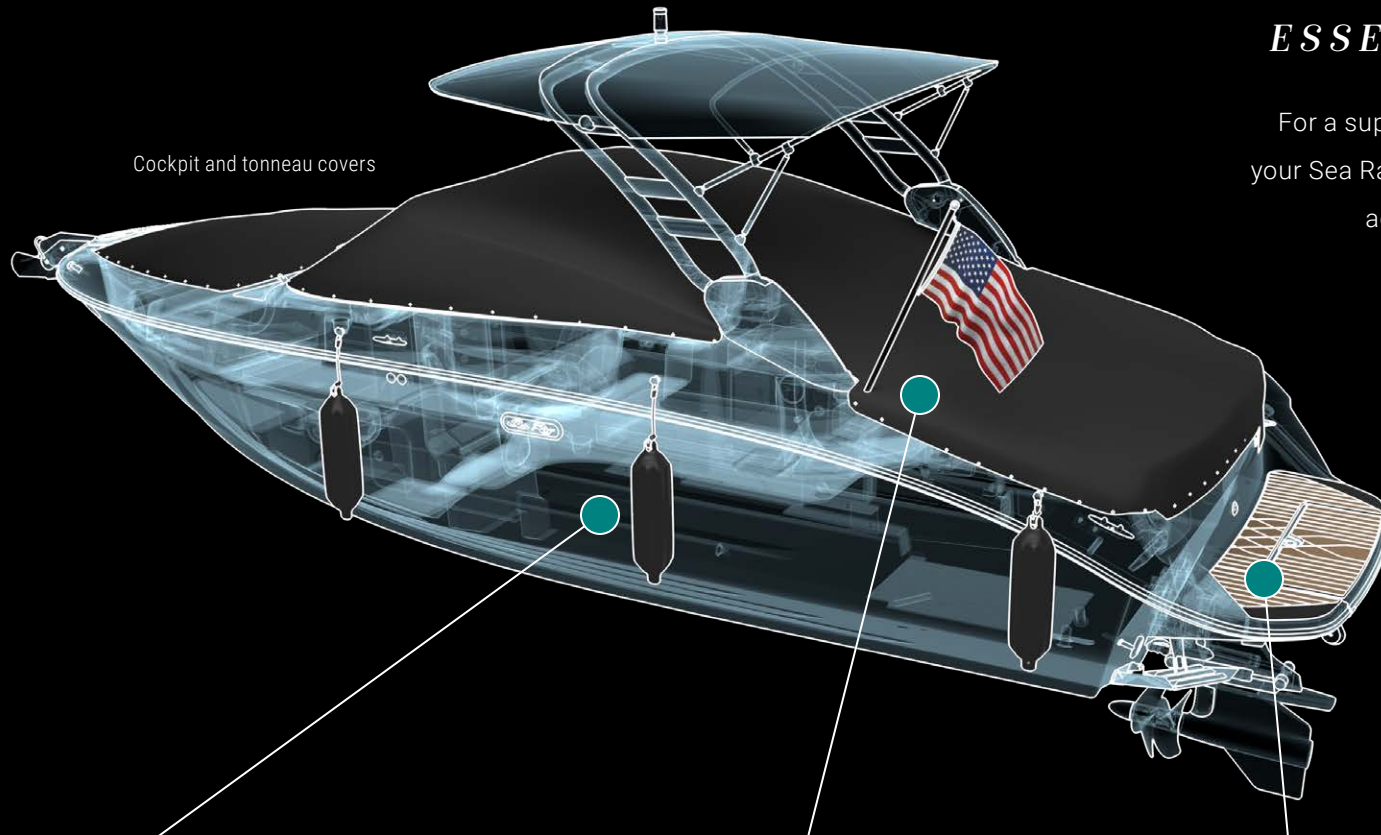

Cockpit and tonneau covers



Quick connect fender clips



Flagpole with base and U.S. flag



SeaDek® swim platform flooring

LIGHTING BUNDLE

Transition from day to night during a sunset cruise or twilight excursion with illuminating features that enhance the ambience.



LED color-changing and white accent lighting package



Illuminated Sea Ray badge



Docking lights

WATER SYSTEM BUNDLE

Rinse sand from your Sea Ray and gear while out on the water with a convenient bow washdown and transom sprayer.



Transom pullout sprayer

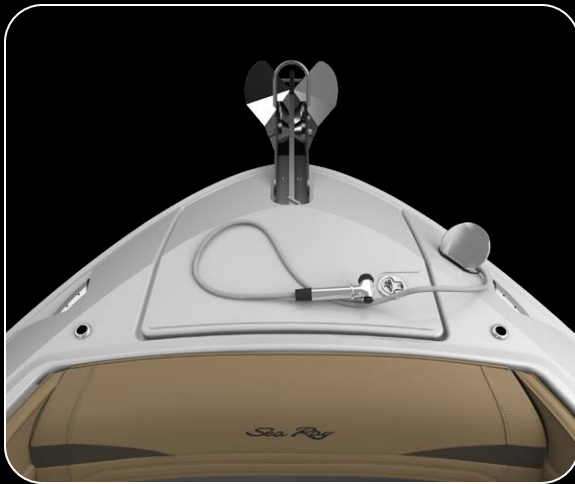

Bow washdown

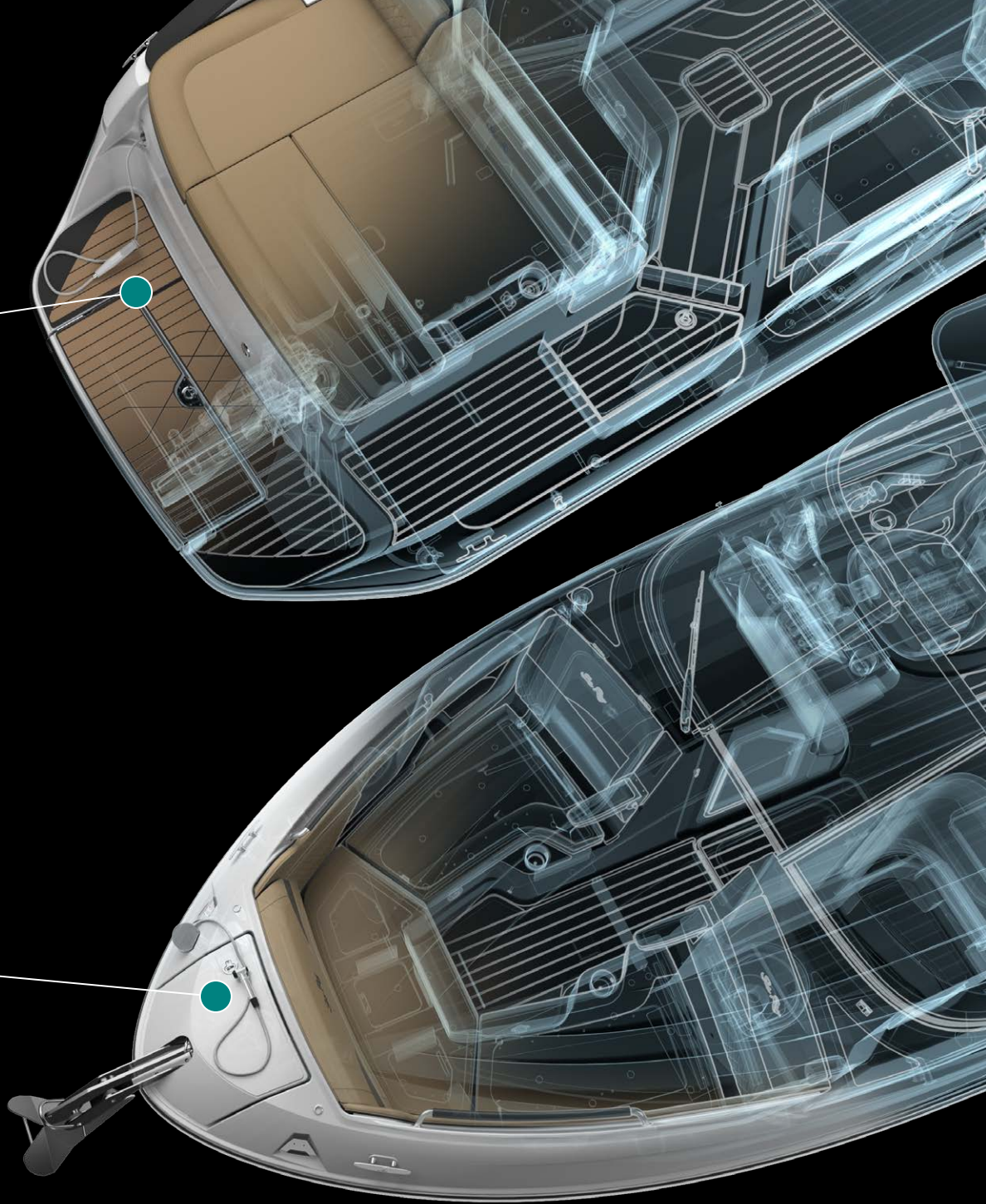

LAYOUT



DECK / COCKPIT

CENTER OF GRAVITY & TECHNICAL MEASUREMENTS

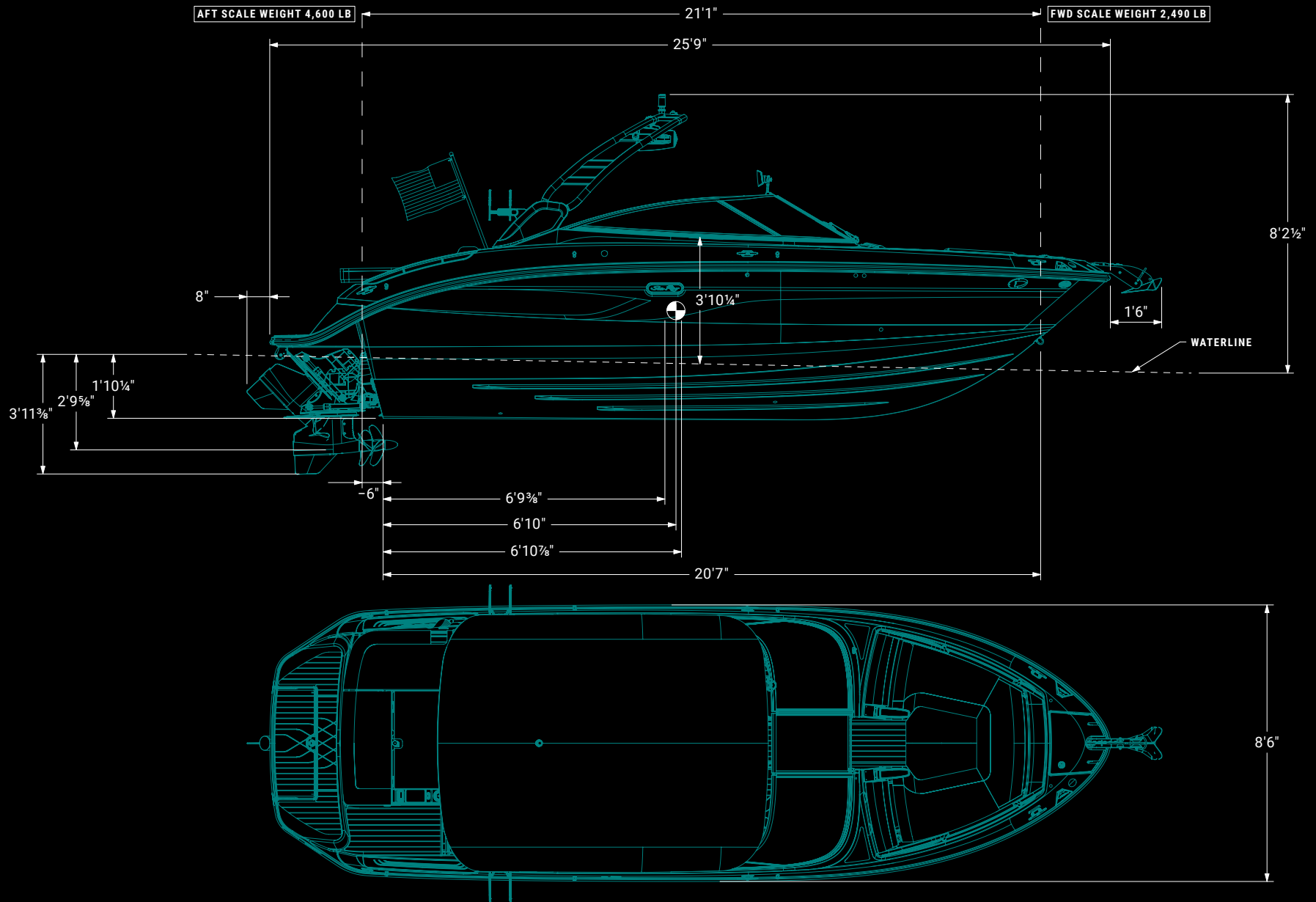



AT SEA RAY, WE BELIEVE THAT RICHER MOMENTS ON THE
WATER LEAD TO A RICHER LIFE. THAT'S WHY EVERYTHING
WE DO IS DESIGNED TO MAKE EACH MOMENT EXCEPTIONAL.

11142025

© 2025 Sea Ray Boats | 800 South Gay Street, Suite 1500, Knoxville, TN 37929 | searay.com

Features, options and specifications are subject to change and may vary for different model years. Some accessories may not be available (a) as standard features or upgradeable options, or (b) when a boat is built for regions outside of North America and/or has CE certification. Confirm specifications and availability of features and options with an authorized Sea Ray dealer.

